

PLAN VIEW

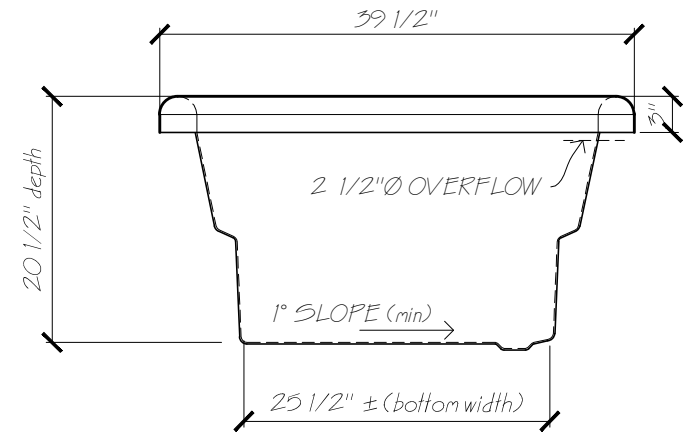

END VIEW

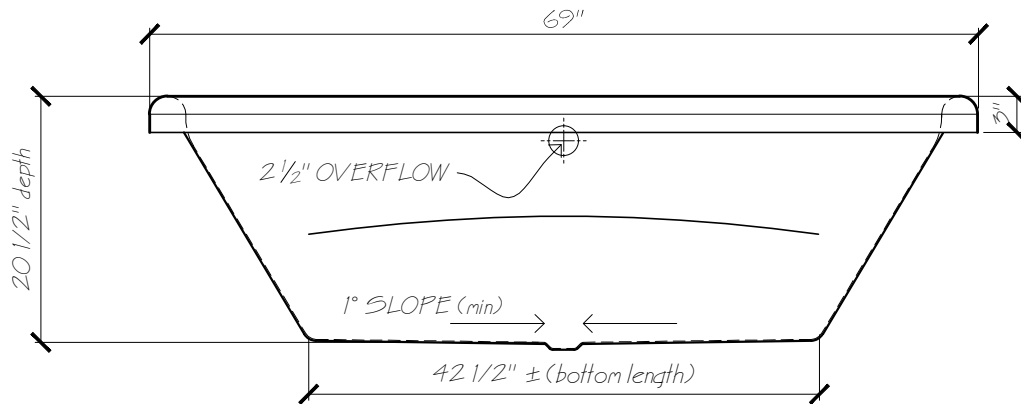

FRONT VIEW



WATER CAPACITY
OPERATIONAL
LEVEL

LITRES: 227 L
GALLONS: 60 G

Name: PACIFIC 2 Oval Bath Tub

Date: 22-06-12

Scale: 3/4" = 1'

File: Pacific2-3d.dwg

Drawn: AAJ



Phone: 604-854-5757

Fax: 604-852-1850