

PLAN VIEW

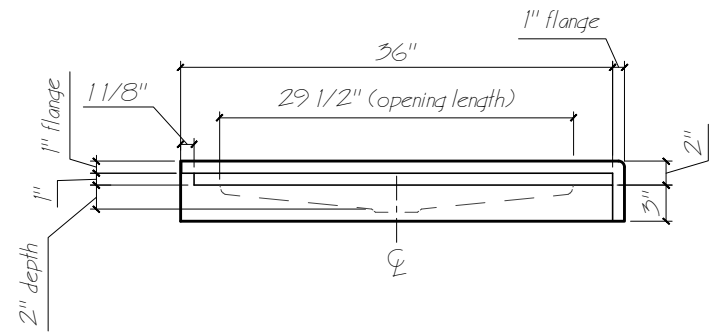

FRONT VIEW



RIGHT END VIEW



Name: SB4236DTR(LT) (Shower Base)

Date: 12-10-17

Scale: 3/4" = 1'

File: SB4236DTR(LT) Drawn: AAJimenez



Phone: 604-854-5757

Fax: 604-852-1850